

COOKING EQUIPMENT
CHARBROILER RANGE



HOBART UK,
SOUTHGATE WAY,
ORTON SOUTHGATE,
PETERBOROUGH
PE2 6GN
TELEPHONE - 0844 888 7777
www.hobartuk.com

Charbroiler Range - LPG Gas

BCB900-2

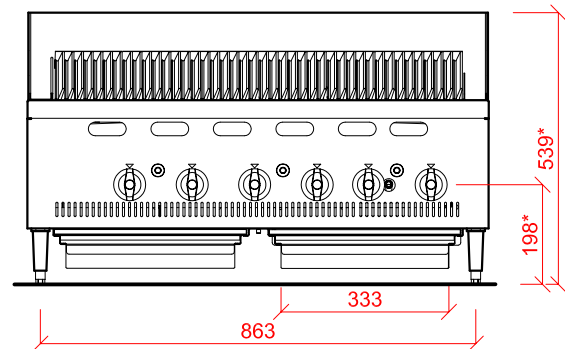
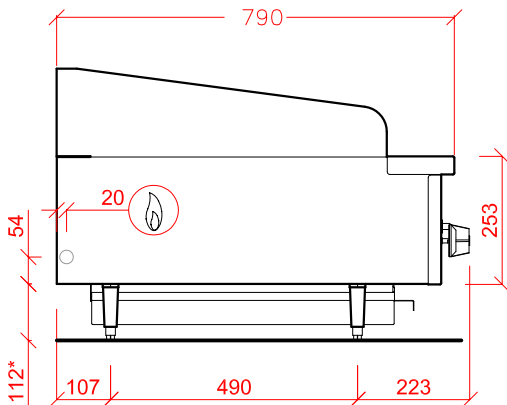
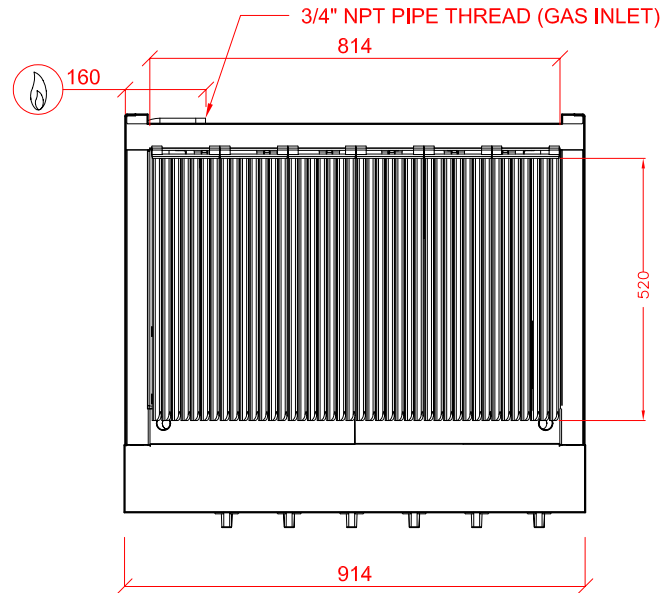

Device Number	Description	Gas	Dimensions (m.m.) (w x d x h)
BCB900-2	GAS CHARBROILER - (LPG Gas). (WITH PIEZO IGNITION).	22.2kW / (75,770BTU/H)	914 x 790 x 539* * ± 12m.m.

22m.m. CONNECTION, 37mBAR

SPECIAL NOTE:
INSTALLATION MUST COMPLY WITH CURRENT GAS SAFETY REGULATIONS AND BS 6173

UNIT WEIGHT - 122kg

PLOT SCALE: 1:15