

Free Standing

FD3-300T-4

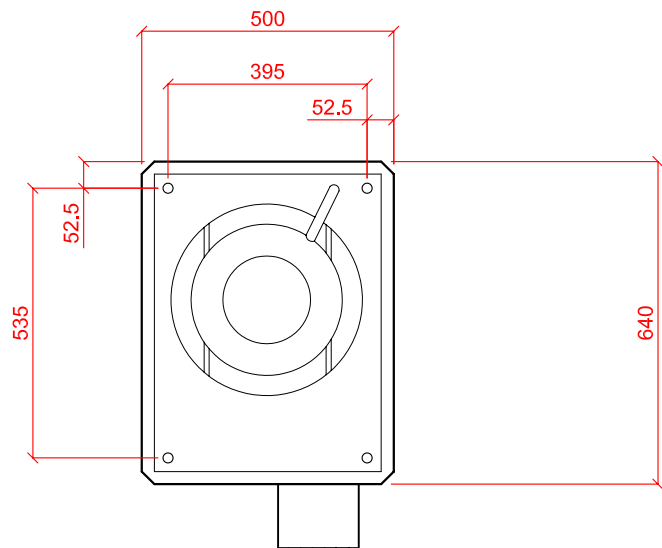
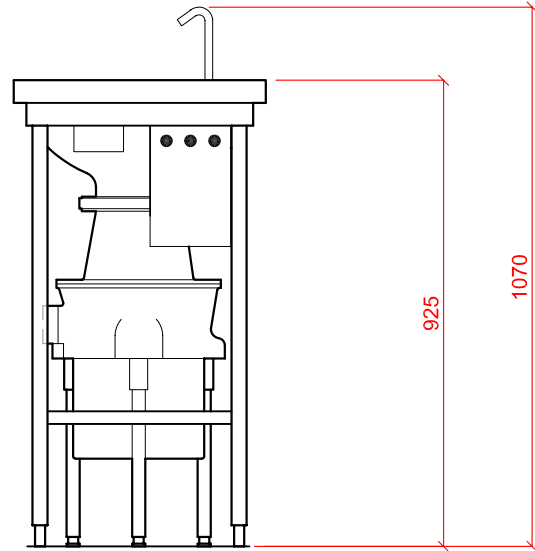
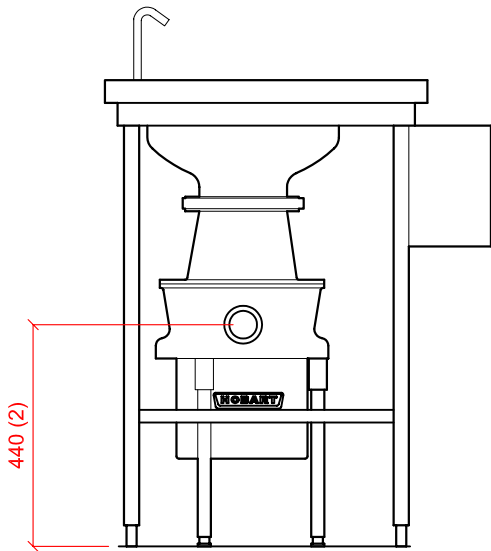

1 Water	2 Drain	3 Electric Loading
<p>3/4" B.S.P. 30°C MAX VIA SOLENOID ON WDU TO GOOSENECK 1.5 TO 8.0 BAR.</p> <p>USAGE 36 LITRES/MINUTE.</p> <p>WATER SUPPLY TO HAVE INDEPENDENT ISOLATING VALVE</p>	<p>2.0" B.S.P. THROUGH TRAP AND DRAIN (NOT BY HOBART), - MUST NOT GO THROUGH A GREASE TRAP.</p>	<p>2.2kW 400/50/3 + N FUSE AT 15AMPS/PHASE.</p> <p>NO CABLE SUPPLIED.</p> <p>SPECIAL NOTE: ELECTRICAL INSTALLATIONS SHOULD COMPLY WITH CURRENT BS REGULATIONS.</p>
<p>RIGHT TO MAKE NECESSARY CHANGES IS RESERVED</p>		