

COMBINATION OVENS
CHEFMATE SERIES



Hobart Cooking Solutions

Southgate Way
Orton Southgate
Peterborough
PE2 6GN

Telephone - 0844 225 1999
www.hobartuk.com/cooking

Chefmate Basic Touch Gas 6 Grid Combination Oven

HCSCMG6

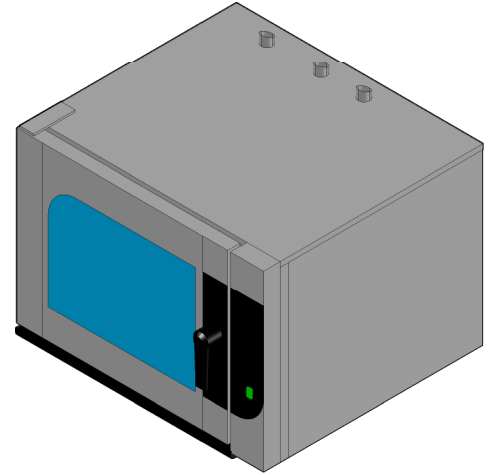
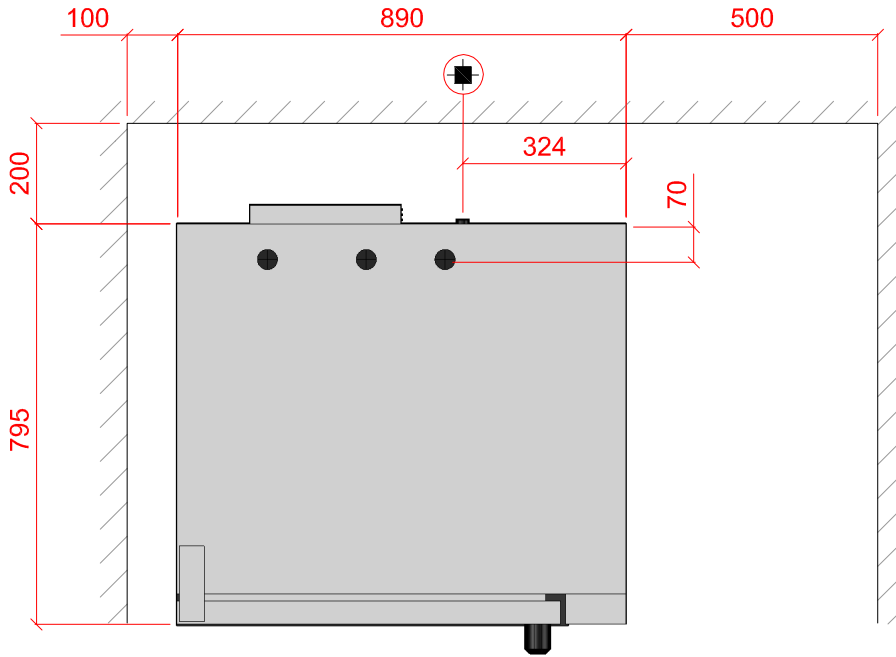

Plan View Showing
Suggested Install/Service
access Clearances

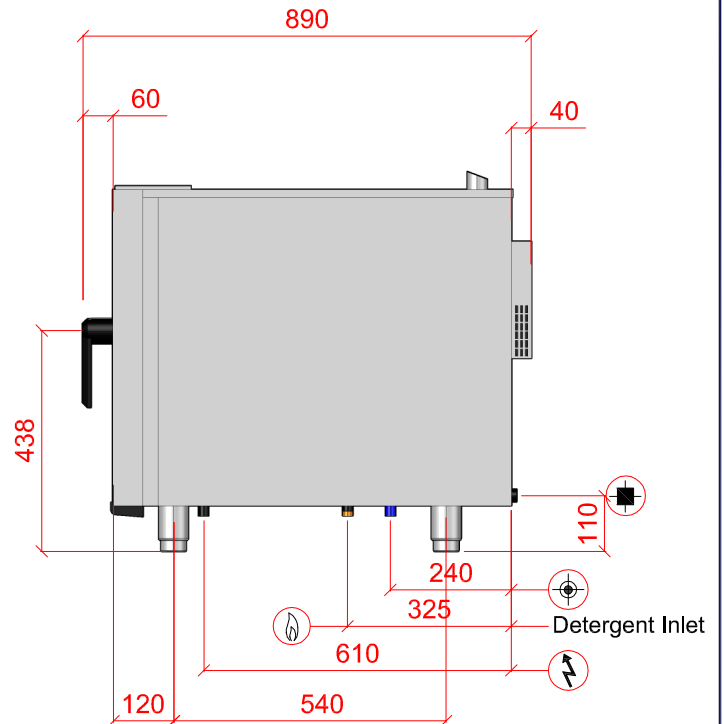
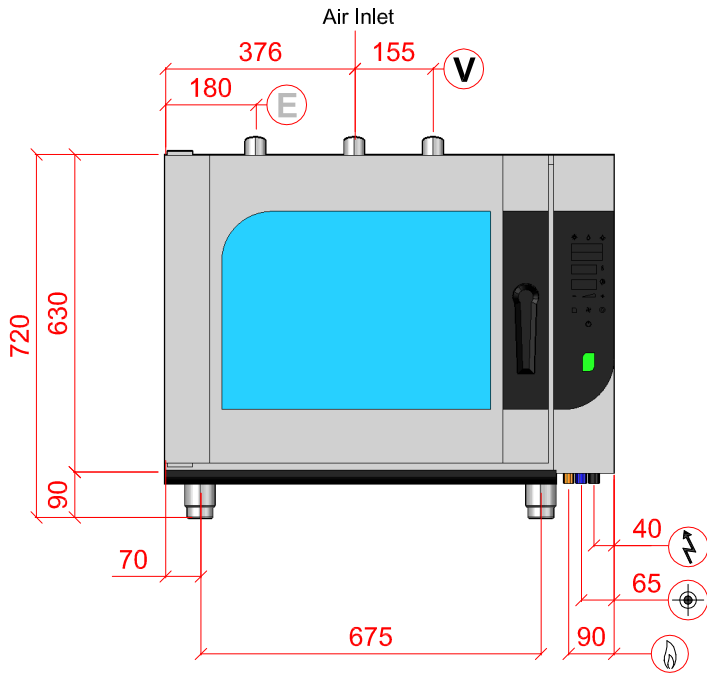

Temperature Cooking Range - 40 to 250°C

Water	Drain	Electric Loading	Gas Loading	Vent Outlet
3/4" B.S.P. POTABLE WATER, 2.0 TO 4.0 BAR MAX PRESSURE. MAX TEMP: 30°C (2 TO 5° CLARK MAX) 5°e, 70ppm - MAX WATER HARDNESS PERMITTED. WATER QUALITY: MAXIMUM CONCENTRATION OF CHLORIDE Cl:100mg/l AND CHLORINE Cl:0.2mg/l	1" DRAIN CONDENSATE TEMPERATURE APPROX 98°C	0.7kW 230/50/1 FUSE AT 13 AMP	12.5kW Connection 3/4" M	Ø40mm Recommended Extraction Flow 390m3/hour
<p>SPECIAL NOTE: DO NOT INSTALL UNIT CLOSE TO HOT APPLIANCES ON CONTROL PANEL SIDE UNIT SHOULD BE LOCATED UNDER A VENTILATION CANOPY. RECOMMENDED TO BE USED WITH A WATER TREATMENT SYSTEM. WEIGHT 140kg net</p>				
RIGHT TO MAKE NECESSARY CHANGES IS RESERVED				

GAS CONNECTION 20mbar
 ELECTRICAL CONNECTION
 WATER CONNECTION
 DRAIN
 VENT OUTLET
 EXHAUST BURNT GAS

SPECIAL NOTE: INSTALLATION MUST COMPLY WITH CURRENT GAS SAFETY REGULATIONS AND BS 6173

PLOT SCALE: 1:15